

INFO
Valve Solutions

The new dimension:
Motorized HVAC valves from Belimo

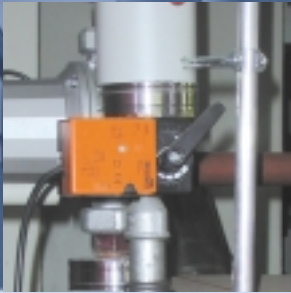

BELIMO[®]
Actuators for heating,
ventilation, air-conditioning



Top economy with motorized control valves from Belimo



Ventilation and safety damper actuators for efficient HVAC installations



Motorized fire and smoke dampers protect both people and property

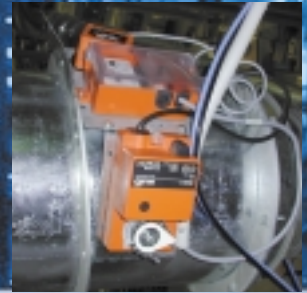

VAV equipment produces a more comfortable atmosphere in individual rooms

The new dimension: Total solutions for motorized HVAC actuators



Actuator technology for heating, ventilating and air-conditioning. For more than 25 years the name Belimo has stood for innovation, quality and reliability in the field of electric motorized actuators for air, fire and smoke dampers and VAV units. With its innovative control valves and valve actuators the company is now also starting to set new standards in the field of cooling and heating circuits in HVAC plants – not only with products and technology but also with the consultancy and services that it offers.

Universal, simple and open. Belimo offers the widest possible range of products for the motorizing of air control dampers and valves for use anywhere in HVAC systems. Sophisticated actuator concepts make them easy to use as well as ensuring excellent functionality and economy. Open interfaces guarantee compatibility with other leading makes of plant and equipment. So everyone can be more independent – also when it comes to purchasing suitable products.

Maximum functionality for heating, ventilating and air-conditioning systems

- ① Air control damper and electric spring-return actuator with safety function
- ② Fire damper and electric spring-return actuator
- ③ VAV-Box with air volume controller and electric damper actuator
- ④ Air control damper and electric damper actuator

- ⑤ 3-way control valve and electric linear actuator
- ⑥ SuperCompact-control valve and electric linear actuator or 2-way control ball valve and electric rotary actuator
- ⑦ 3-way control ball valve and electric rotary actuator

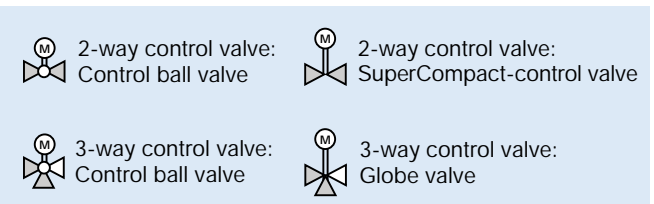
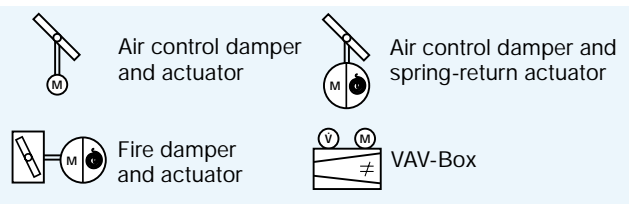
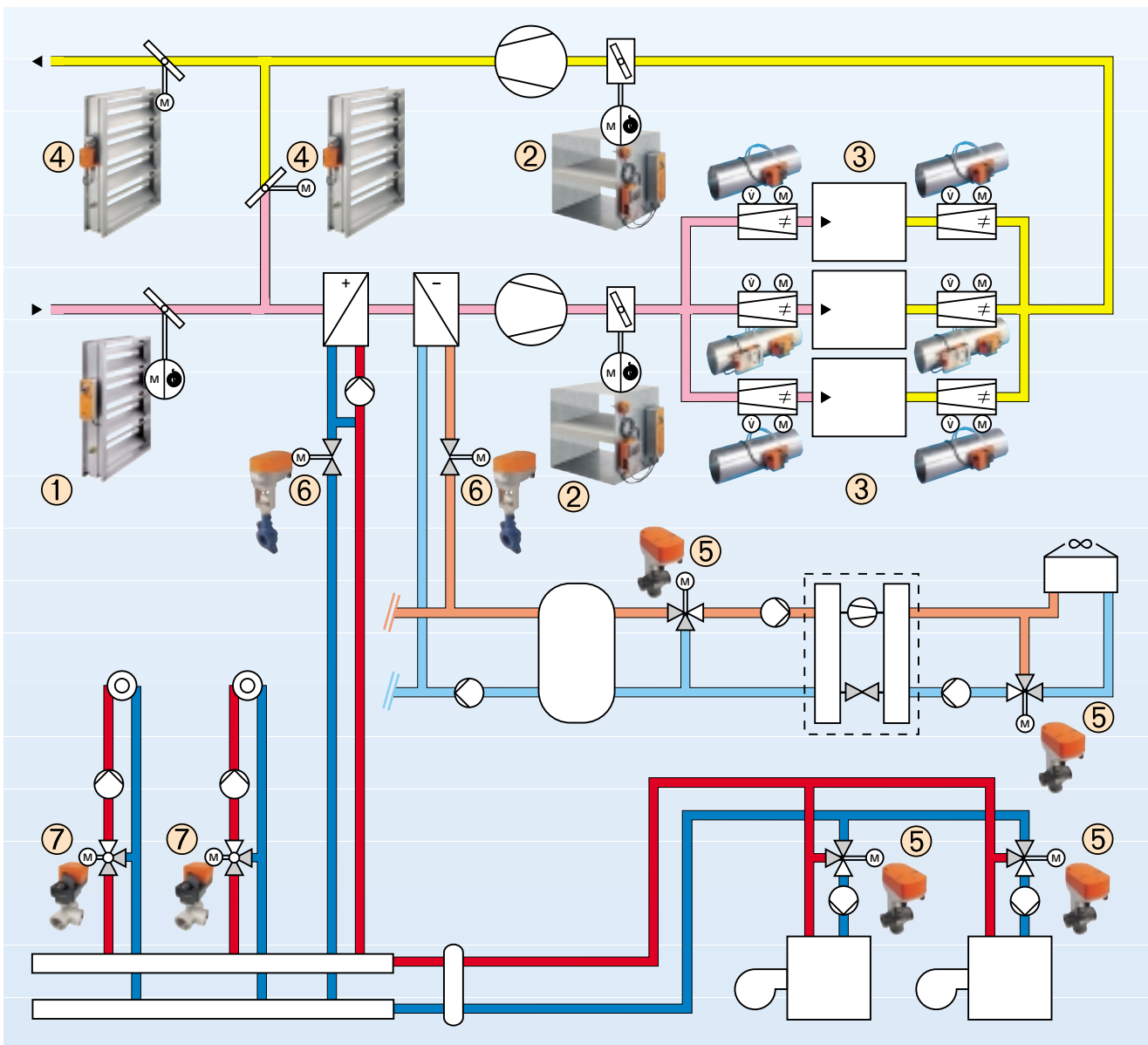



The unique characterizing disk has turned the ball valve into a full-feature control valve



Slim, light and controllable – the SuperCompact-control valve and intelligent actuator

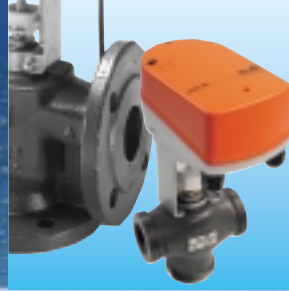

Linear control valves and innovative actuators with MFT® Multi-Function Technology



Linear actuators for retrofitting to all leading makes of valve

The new dimension: Innovative control valves with smart actuators

Ball valve becomes control device. Belimo is helping to set new standards in the field of valves too. A specially developed characterizing disk has turned the ordinary ball valve into a low-cost, full-feature control device. This allows it to have an equal-percentage characteristic – which a conventional ball valve does not, of course. Combined with a top-quality actuator the control ball valve has become a truly economic alternative to a globe valve of the same size.

SuperCompact-control valve with intelligent actuator. Thanks to it being motorized with an intelligent Belimo linear actuator, the conventional compact valve for throttling and shut-off applications has evolved into a full-feature control device. This has given the competitively-priced SuperCompact-control valve access to the applications of the classic flanged control valve – providing all the same advantages but without the usual bulkiness and weight.

Belimo control valves for all applications

Globe valve with linear actuator, flanged

This is a classic globe valve with an equal-percentage characteristic for controlling high to low flow rates. Available as two-way valve or mixing valve with flanged ends. It is also suitable for Open/Close applications. Actuators with an emergency control function are available.

SuperCompact-control valve with linear actuator, flanged







With an equal-percentage characteristic (standard) or a linear characteristic (optional) for controlling high to low flow rates. It is available as a two-way valve in intermediate-flange form. It is also suitable for Open/Close applications.

Globe valve with linear actuator, male screw

The classic globe valve with an equal-percentage characteristic for controlling medium to low flow rates. Available as a two-way valve or a mixing valve with male screwed ends. It is also suitable for Open/Close applications. Actuators with an emergency control function are available. Optional: screw pipe connectors are available.

Control ball valve with rotary actuator, female screw

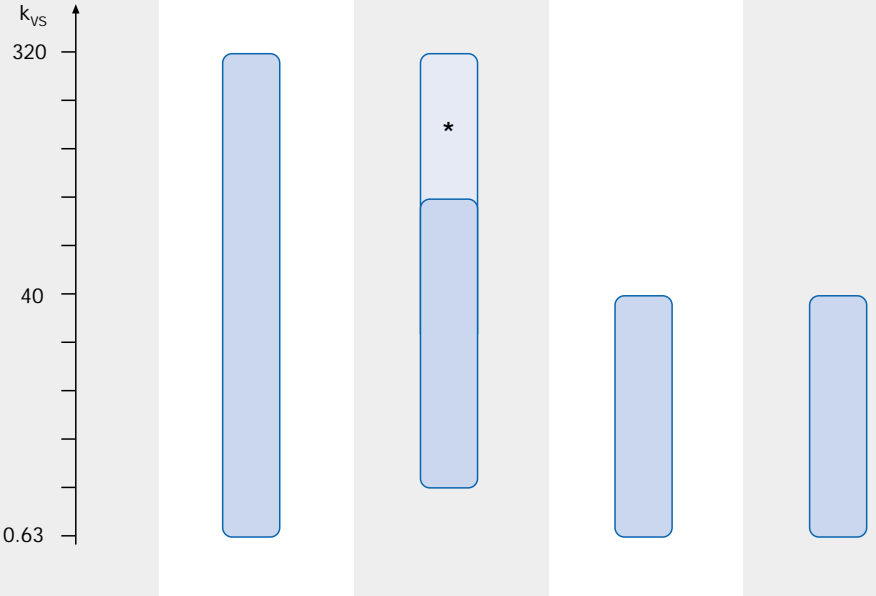
Mixing valve with female screwed ends and an equal-percentage characteristic for controlling medium to low flow rates. It is also suitable for Open/Close applications. Optional: screw pipe connectors are available.

| Specifications | Flanged | | Male screw | Female screw |
|---|---|--|---|---|
| |  |  |  |  |
| | Globe valves | SuperCompact-control valve | Globe valves | Control ball valve |
| Flow [m ³ /h] k _{VS} |  | | | |
| 2-way  | H6 | S6 | H4 | R2 |
| 3-way  | H7 | - | H5 | R3 |
| DN | 15–150 | 20–80 (up to 150*) | 15–50 | 15–50 |
| PN | 16 | 6/10/16 | 16 | 16 |

*to order

Globe valves with bus-capable actuators. For new installations Belimo can offer a selected range of globe valves in all the usual nominal sizes. The actuators that are used with them can satisfy almost all application requirements. The MFT® types which use Multi-Function Technology offer especially fine performance: their digital control system allows very precise setting and adjustment as well as linking easily into field bus systems.

Converting and retrofitting globe valves. Belimo offers a wide range of intelligent linear actuators for the motorizing and/or conversion and retrofitting of all leading makes of valve. This also means, of course, that existing equipment can be upgraded to the latest state-of-the-art at minimum cost. Suitable brackets make mounting the actuators a very simple task requiring no special tools.



It is our highly-specialized expertise and years of experience that allows us to produce the best solutions for specific needs

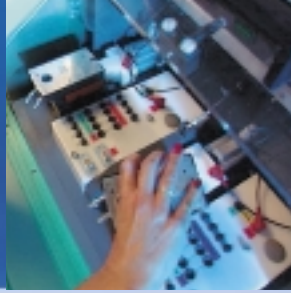

Efficient production and tough inspection procedures ensure top quality and excellent value for money



Our logistics capability and world-wide distribution network ensures wide availability and short deliveries



On-site advice and support from Belimo staff is the best way to achieve economic total solutions to problems

The new dimension: Top-class service from the world market leader



World market leader. In Europe at present, two out of three actuators being installed on ventilation dampers come from Belimo. In the USA the company's market share is nearly 50%. This leading position in the world is the result of the strong emphasis that we have put on HVAC actuator technology combined with our close proximity to global markets – we have our own General Agents and Representatives in more than 50 countries to keep in direct touch with our customers.

Actuator solutions from a single source. Thanks to specialized know-how and a detailed knowledge of the market Belimo is able to develop cost-effective solutions that can be tailored very accurately to users' widely-varying needs and requirements. It is all based on a total philosophy whose main aim, whatever the situation, is to offer users the very best products with which to achieve the efficient and economic motorizing of all kinds of HVAC actuators.

Top-class advice and support for the planning, execution and operation of HVAC installations



On-site advice and support. Experienced members of Belimo staff from local sales and engineering offices can provide customers with all the support they need while they are designing and implementing their systems – and extra technical support is easily available from Head Office too if necessary. Although such support primarily involves providing detailed information on products it can also extend to attending personal site meetings, and even to providing practical help and assistance when necessary.

Quality, service and information. Belimo is setting new standards for everyone in other areas too – quality-awareness, short delivery times and a proven range of services, as well as a well thought-out sales and marketing system ensuring total product availability. A very comprehensive and thorough service organisation offers round-the-clock access to all relevant data – either by personal contact or through electronic IT systems.

Air applications



Standard actuators and spring-return actuators for air control dampers in HVAC systems



Safety actuators for motorizing fire and smoke extraction dampers



VAV systems for individual room air control

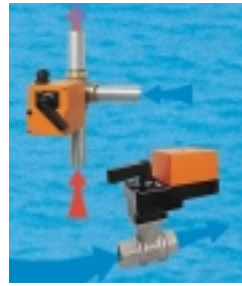

Mixing actuators and motorized ball valves for HVAC water circuits



Globe valves and intelligent linear actuators – also for leading makes of valve

Innovation, Quality and Consultancy: A partnership for motorizing HVAC actuators

Contact the following for further information:

Belimo Headquarters

CH BELIMO Holding AG
Guyer-Zeller-Strasse 6
8620 Wetzikon, Switzerland
Tel. ++41 (0)1 933 11 11
Telefax ++41 (0)1 933 12 68
E-Mail: info@belimo.ch
Internet: http://www.belimo.ch

Belimo Subsidiaries

AT/ BELIMO Automation
Handelsgesellschaft m.b.H.
Geiselbergstrasse 26-32
1110 Wien, Austria
Tel. ++43 (0)1 749 03 61-0
Telefax ++43 (0)1 749 03 61-99
E-Mail: info@belimo.at

CA BELIMO Aircontrols (CAN), Inc.
5716 Coopers Ave., Units 14&15
Mississauga, Ontario L4Z 2E8
Canada
Tel. ++1 (1)905 712 31 18
Telefax ++1 (1)905 712 31 24
E-Mail: webmaster@belimo.com

CH BELIMO Automation AG
Sales Switzerland
Guyer-Zeller-Strasse 6
8620 Wetzikon, Switzerland
Tel. ++41 (0)1 933 12 12
Telefax ++41 (0)1 933 12 66
E-Mail: verkch@belimo.ch
Internet: http://www.belimo.ch

DE BELIMO Stellantriebe
Vertriebs GmbH,
Welfenstr. 27, Postfach 72 02 30
70599 Stuttgart, Germany
Tel. ++49 (0)711 1 67 83-0
Telefax ++49 (0)711 1 67 83-73
E-Mail: info@belimo.de
Internet: http://www.belimo.de

ES BELIMO Iberica
de Servomotores, S.A.
C/San Romualdo, 12-14
28037 Madrid, Spain
Tel. ++34 91 304 11 11
Telefax ++34 91 327 25 39
E-Mail: info@belimo.es

FR BELIMO Servomoteurs
Z.A. de Courty
33, Rue de la Régale
77181 Courty, France
Tel. ++33 (0)1 64 72 83 70
Telefax ++33 (0)1 64 72 94 09
E-Mail: mail@belimo.fr

GB BELIMO Automation UK Limited
The Lion Centre
Hampton Road West
Feltham, Middlesex, Great Britain
TW 13 6DS
Tel. ++44 (0)20 8755 4411
Telefax ++44 (0)20 8755 4042
E-Mail: belimo@belimo.co.uk

HK BELIMO Actuators Ltd.
Room 208, 2/F
New Commerce Centre
19 On Sum Street, Shatin, N.T.
Hong Kong
Tel. ++852 26 87 17 16
Telefax ++852 26 87 17 95
E-Mail: info@belimo.com.hk

SG BELIMO Actuators Pte Ltd
2, Jurong East Street 21
#04-31F IMM Building
Singapore 609601
Tel. ++65 564 9828
Telefax ++65 564 9038
E-Mail: singapore@belimo.com.hk

US BELIMO Aircontrols (USA), Inc.
43 Old Ridgebury Road
P.O. Box 2928
Danbury, CT 06810 USA
Tel. ++1 (1)203 791 99 15
Telefax ++1 (1)203 792 29 67
E-Mail: webmaster@belimo.com
Internet: http://www.belimo.com

Belimo Representatives and Agencies

AE BELIMO Automation
Middle East Office
P.O. Box 55427
Dubai, U.A.E.
Tel. ++971 (0)4 387 417
Telefax ++971 (0)4 387 415
E-Mail: belimome@emirates.net.ae

AU BELIMO Australia Pty. Ltd.
P.O. Box 990,
Braeside VIC 3195, Australia
Tel. ++61 (03) 9587 8244
Telefax ++61 (03) 9587 8233
E-Mail: belimo@net2000.com.au

BE BELIMO Automation N.V.-S.A.
Leuvensesteenweg 613
1930 Zaventem, Belgium
Tel. ++32 (0)2 757 92 95
Telefax ++32 (0)2 757 90 36
E-Mail: info@belimo.be

BG BELIMO Bulgaria Ltd.
j.k. Borovo, bl. 223A
entr. B, ap. 25
1680 Sofia, Bulgaria
Tel. ++3592 958 18 04
Telefax ++3592 54 58 95
E-Mail: belimo@intech.bg

CN BELIMO Actuators Ltd.
18 FA3, 585 Longhua West-Road
200232 Shanghai, China
Tel. ++86 21 6469 2895
Telefax ++86 21 6469 2909
E-Mail: shanghai@belimo.com.hk

CN BELIMO Beijing
Rm 605, Beijing Hai Chang
Edifice, 44, Liang Ma Qiao Road
Chao Yang District
100016 Beijing, China
Tel. ++86 10 6462 1382
Telefax ++86 10 6462 1383
E-Mail: beijing@belimo.com.hk

CY R.E.S. Ltd.
P.O. Box 8297
Nicosia, Cyprus
Tel. ++357 (0)2 51 10 07
Telefax ++357 (0)2 49 65 47
E-Mail: reliance@spidernet.com.cy

CZ BELIMO CZ (Ing. Ivar Mentzl)
Charkovská 16
10100 Praha 10, Czech Republic
Tel. ++420 (0)2 717 4 0 311
Telefax ++420 (0)2 717 43 057
E-Mail: info@belimo.cz

DK BELIMO A/S
Thomas Helstedsvvej 7
8660 Skanderborg, Denmark
Tel. ++45 86 52 44 00
Telefax ++45 86 52 44 88
E-Mail: info@belimo.dk

EE BELIMO Balticum AS
Toostuse 3
10413 Tallinn, Estonia
Tel. ++372 6 414 112
Telefax ++372 6 414 113
E-Mail: kari.manninen@belimo.ee

FI Oy Suomen BELIMO Ab
Insinöörinkatu 2
00810 Helsinki, Finland
Tel. ++358 (0)9 75 11 65 00
Telefax ++358 (0)9 75 11 65 31
E-Mail: belimo@belimo.fi

GR BELIMO Air Controls
29, Tagm. Plessa, Kallithea
GR 17574 Athens, Greece
Tel. ++30 (0)1 94 00 766
Telefax ++30 (0)1 94 00 767
E-Mail: belimogr@tee.gr

HR/ SI BELIMO d.o.o.
Puzev breg 1
51211 Matulji, Croatia
Tel. ++385 (0)51 27 24 81
Telefax ++385 (0)51 27 24 81
E-Mail: belimo@ri.tel.hr

IT BELIMO Servomotori S.r.l.
Via Stezzano, 5
24050 Zanica BG, Italy
Tel. ++39 035 67 26 82
Telefax ++39 035 67 02 00
E-Mail: bedema@tin.it

IE Safeguard Systems Ltd.
Systems House, Unit 34
Southern Cross Business Park
Bray, Co Wicklow, Ireland
Tel. ++353 (0)1 2761600
Telefax ++353 (0)1 2761611
E-Mail: safeguard@iol.ie

IL Shemer Representations
P.O. Box 296
56101 Yehud, Israel
Tel. ++972 3 536 51 67
Telefax ++972 3 536 05 81
E-Mail: shem_rep@netvision.net.il

IN BELIMO Vitek Air Controls
C-114 Lancelot, First Floor
S.V. Road, Borivali (West)
Mumbai 400 092, India
Tel. ++91 22 806 21 63
Telefax ++91 22 806 21 63
E-Mail: bvac@bom2.vsnl.net.in

IS Hitataekni ehf.
Langholtsveggi 109
104 Reykjavik, Iceland
Tel. ++354 5 88 60 70
Telefax ++354 5 88 60 71
E-Mail: fridmar@hitataekni.is

LB Energy Center (EC)
Hamra, Leon Street, Shatilla,
Bldg. 4th Floor.
P.O. Box 113-6955
Beirut, Lebanon
Tel. ++961 (0)1 35 38 23
Telefax ++961 (0)1 35 38 23
E-Mail: belimome@emirates.net.ae

MA BELIMO Maghreb
Monica Plage, Villea No. 71
Mohammedia 20650, Morocco
Tel. ++212 2 331 26 59
Telefax ++212 2 331 32 76
E-Mail: belimo.maghreb@wanadoo.net.ma

NO BELIMO Spjeldmotorer A/S
Konovsgate 5
0192 Oslo 1, Norway
Tel. ++47 22 70 71 71
Telefax ++47 22 70 71 70
E-Mail: belimo@online.no

NL BELIMO Servomotoren B.V.
Radeweg 25, 8171 MD Vaassen
Postbus 300, 8160 AH Epe,
Netherlands
Tel. ++31 5 78 57 68 36
Telefax ++31 5 78 57 69 15
E-Mail: info@belimo.nl

NZ Modulair New Zealand Ltd.
P.O. Box 40033
Upper Hutt, New Zealand
Tel. ++64 4 388 48 03
Telefax ++64 4 388 48 03

PH BELIMO Actuators Philippines
Rm.# 507 Anita Build., 5th Floor
1300 Quezon Ave., Cor.South Ave.
1103 Quezon City, Philippines
Tel. ++63 (2) 373 5440
Telefax ++63 (2) 373 5424
E-Mail: philippines@belimo.com.hk

PK Union Dynamics Corporation
B-152 Unit 7-8 Chandni Plaza
Chandni Chowk, Satellite Town,
Rawalpindi, Pakistan
Tel. ++92 (0)51 45 40 39
Telefax ++92 (0)51 42 23 01

PL BELIMO Sp z o.o.
ul. J. Smulikowskiego 4a
00-389 Warszawa, Poland
Tel. ++48 (0)22 826 24 32
Telefax ++48 (0)22 826 10 10
E-Mail: sprzedaz@belimo.com.pl

RU BELIMO Servomotors
Russia Ltd.
BELIMO Vitek Pervomayskaya,
46 Bld-1, Office 303
105203 Moscow, Russia
Tel. ++7 095 965 74 64
Telefax ++7 095 965 74 73
E-Mail: belimo.russia@mtu-net.ru

RO Mano Construct srl
Dr Felix 53, ap 14, sector 1
Bucuresti, Romania
Tel. ++401 220 05 78
Telefax ++401 221 59 95
E-Mail: manoconstruct@fx.ro

SE BELIMO Spjällmotorer AB
Hägerstens Allé 88
129 37 Hägersten, Sweden
Tel. ++46 (0)8 88 07 00
Telefax ++46 (0)8 97 85 75
E-Mail: info@belimo.se

SK MARET System
Malinského 34
91501 Nové Mesto n.V., Slovakia
Tel. ++421 (0)834 71 61 66
Telefax ++421 (0)834 71 21 61
E-Mail: mare@internet.sk

SY Philippe A. Jebran
P.O. Box 7791
Damascus, Syria
Tel. ++963 11 231 6586
Telefax ++963 11 231 4052
E-Mail: belimome@emirates.net.ae

TR BELIMO Otomasyon A.S.
Hayriye Caddesi No. 16
TR-80060 Galatasaray-Istanbul
Turkey
Tel. ++90 (0)212 249 76 43
Telefax ++90 (0)212 243 02 58
E-Mail: info@belimo.com.tr

TW Chianseng Enterprise Co. Ltd.
2F, No. 21, Tong Fong Street
Taipei, Taiwan
Tel. ++886 2 27 08 77 80
Telefax ++886 2 27 02 90 90
E-Mail: taiwan@belimo.com.hk

UA IPC Cyclone
34-A, Ul. Yurkovskaya, Appt.№ 2
254080 Kiev, Ukraine
Tel./Telefax ++380 44 463 7586

ZA BELIMO Actuators Southern Africa cc
P.O. Box 2483
Alberton 1450, South Africa
Tel. ++27 (0)11 868 5681
Telefax ++27 (0)11 900 2673
E-Mail: belimo@mega.co.za